

PUBLIC FURNISHING

LITTER BIN RANGE



ORIGINAL PRODUCTS FOR PUBLIC SPACES

INHALT

Product families.....	04
Post-mounted bins.....	05
Free-standing bins.....	11
Recycling Bins	19
Underground litter bins	23
Container Shelters.....	25
Individual solutions.....	27
Contact.....	28

Technical modifications reserved. Mounting accessories obtainable as extras on request. Protected design and structural features. Non standard colours and materials on request. Please see our data sheets for further details.

Picture credits: fotolia.com / © ESE World BV



CLEANLINESS

IN PUBLIC SPACES



Enabling cleanliness is our strong point! We have successfully manufactured waste disposal containers and systems for public and semi-public spaces for over 80 years. During this time, in close association with our customers, we have developed a wide range of litter bins and containers adapted to market requirements.

SERVICE

IN SHOPPING CENTRES



Give a good impression on the way to shopping centres. The surroundings of buildings strongly impact customers' impressions. Provide your customers with facilities so they can act environmentally friendly by introducing attractive and hygienic litter bins. Our clients include cities and local authorities and also largescale and individual commercial chains, which require consistent and good value container solutions for their subsidiaries.

UNIFORMITY

COMPANY PREMISES & TRANSPORT ENVIRONMENTS

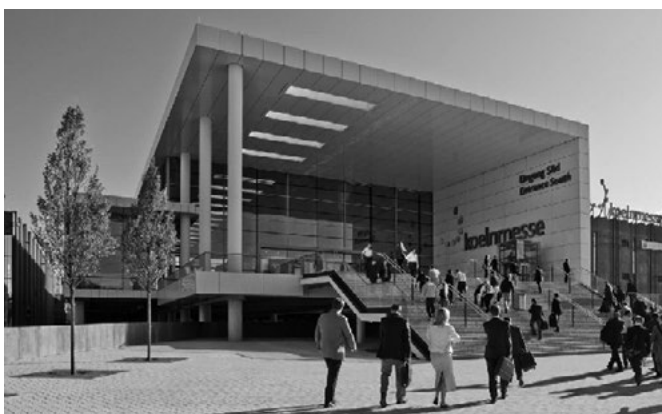

Company premises, trade fair grounds, transport infrastructure, tourism facilities and sports grounds all need to be clean. We can supply appropriate litter bins fitting your corporate appearance, which can be emptied very quickly.

PRODUCT FAMILIES

SANTOLINO
SANTO



PINTOLINO
PINTO

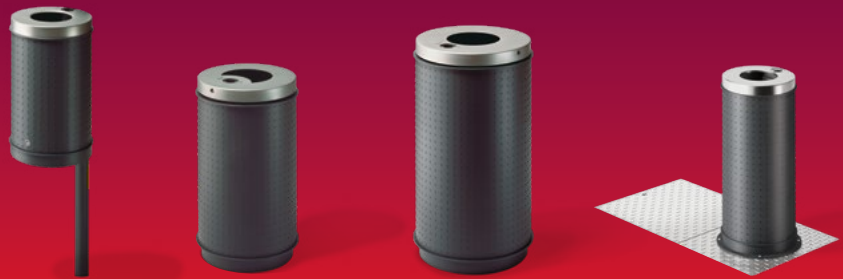

TARLINO
TARA



MARLINO
MARA



PORTELINO
PORTELLO

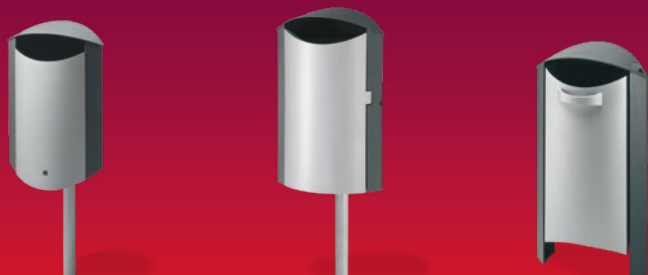

POST-MOUNTED BINS



Public Furnishing - Litter Bin Range
Plastic Post-Mounted Bins

DINOVA

HH 2000



Detail: Ashtray



	Volume	50 l	42 l
	Emptying	Discharge container	Bottom flap
	Material	Plastic	Plastic, galvanised steel
	Weight	4.5 kg	5.7 kg
	Dimensions HxWxD	811 x 480 x 357 mm	600 x 400 x 306 mm
	Colours		
	Options	Ashtray, bag holder	

STRADA

V 3000 B



Detail: Ashtray

	Volume	50 l	50 l
	Emptying	Discharge container	Discharge container
	Material	Plastic	Plastic, galvanised / galvanised-painted steel
	Weight	6.5 kg	6.3 kg
	Dimensions HxWxD	978 x 470 x 314 mm	695 x 450 x 330 mm
	Colours		
	Options	Ashtray	

CITYBIN

KÖLN



Detail: Ashtray



Detail: Ashtray

	Volume	40 l	45 l
	Emptying	Bottom flap	Bottom flap
	Material	Galvanised / galvanised-painted steel	Galvanised / galvanised-painted steel
	Weight	9.5 kg	9.5 kg
	Dimensions HxWxD	543 x 335 x 380 mm	543 x 335 x 380 mm
	Colours	All RAL and DB colours are available	All RAL and DB colours are available
	Options		

V 3000 B

O 2100



Detail: Ashtray



	Volume	50 l	30 l
	Emptying	Discharge container	Discharge container
	Material	Galvanised / galvanised-painted steel	Galvanised / galvanised-painted steel
	Weight	11.5 kg	5.0 kg
	Dimensions HxWxD	640 x 446 x 330 mm	494 x 305 x 362 mm
	Colours	All RAL and DB colours are available	All RAL and DB colours are available
	Options	Ashtray	

Public Furnishing - Litter Bin Range
Steel Post-Mounted Bins

HH 2000

VENTA



Detail: Ashtray



Detail: Ashtray

	Volume	42 l	70 l
	Emptying	Bottom flap	Bottom flap
	Material	Galvanised / galvanised-painted steel	Galvanised-painted steel
	Weight	9.2 kg	15 kg
	Dimensions HxWxD	600 x 400 x 306 mm	729 x 446 x 360 mm
	Colours	All RAL and DB colours are available	All RAL and DB colours are available
	Options	Ashtray	

KOPENHAGEN

MARLINO



Detail: Ashtray



Detail: Ashtray

	Volume	70 l	60 l
	Emptying	Bottom flap	Waste bag
	Material	Galvanised / galvanised-painted steel	Galvanised-painted steel
	Weight	13.4 kg	21 kg
	Dimensions HxWxD	691 x 456 x 371 mm	635 x 312 x 370 mm
	Colours	All RAL and DB colours are available	All RAL and DB colours are available
	Options	Ashtray	
	Product family		Free standing bin page 14

PINTOLINO

PINTOLINO T

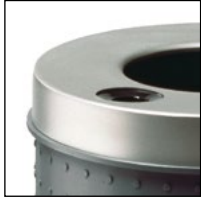

Detail: Ashtray



Detail: Inner liner

	Volume	48 l	45 l
	Emptying	Bottom flap	Inner liner
	Material	Top stainless steel, galvanised-painted steel	Top stainless steel, galvanised-painted steel
	Weight	15.5 kg	21 kg
	Dimensions HxWxD	550 x 346 x 386 mm	550 x 346 x 386 mm
	Colours	All RAL and DB colours are available	All RAL and DB colours are available
	Options	Painted top	Painted top
	Product family	Free standing bin page 16, Underground bins page 24	

TARLINO

TARLINO T



Detail: Ashtray



Detail: Inner liner

	Volume	48 l	45 l
	Emptying	Bottom flap	Inner liner
	Material	Top stainless steel, galvanised-painted steel	Top stainless steel, galvanised-painted steel
	Weight	20.5 kg	28 kg
	Dimensions HxWxD	550 x 346 x 386 mm	550 x 346 x 386 mm
	Colours	All RAL and DB colours are available	All RAL and DB colours are available
	Options	Painted top	Painted top
	Product family	Free standing bin page 13	

Public Furnishing - Litter Bin Range
Steel Post-Mounted Bins

SANTOLINO

SANTOLINO T



Detail: Ashtray



Detail: Inner liner

	Volume	60 l	45 l
	Emptying	Bottom flap	Door / Inner liner
	Material	Galvanised-painted steel	Galvanised-painted steel
	Weight	21 kg	24 kg
	Dimensions HxWxD	702 x 350 x 389 mm	702 x 350 x 389 mm
	Colours	All RAL and DB colours are available	All RAL and DB colours are available
	Options		
	Product family	Free standing bin page 15, Underground bin page 24	

PORTELINO

PORTELINO T



Detail: Ashtray



Detail: Inner liner

	Volume	50 l	47 l
	Emptying	Bottom flap	Door / Inner liner
	Material	Galvanised-painted steel	Galvanised-painted steel
	Weight	20 kg	34 kg
	Dimensions HxWxD	682 x 440 x 257 mm	800 x 504 x 335 mm
	Colours	All RAL and DB colours are available	All RAL and DB colours are available
	Options		
	Product family	Free standing bin page 17	

FREE-STANDING BINS

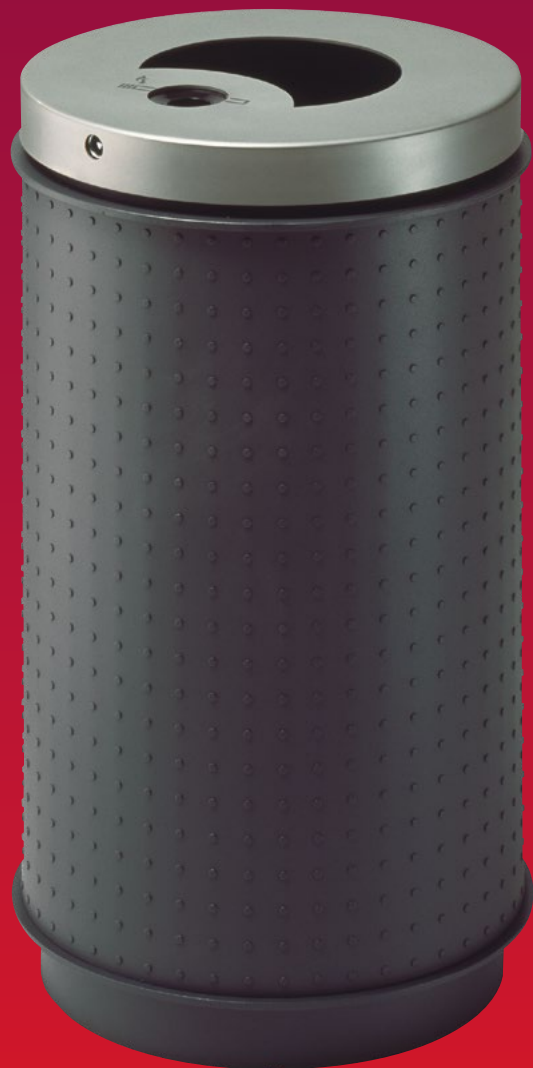

SI 2200



Detail: Ashtray

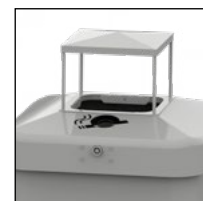

Option: Cover

	Volume	100 l
	Emptying	Inner liner
	Material	Galvanised / galvanised-painted steel
	Weight	66 kg
	Dimensions HxWxD	800 x 484 x 484 mm
	Colours	All RAL and DB colours are available
	Options	

ICON 60



Detail: Ashtray



ICON 100



Detail: Ashtray / Inner liner

	Volume	60 l	100 l
	Emptying	Door / Inner liner	Door / Inner liner
	Material	Galvanised-painted steel	Galvanised-painted steel
	Weight	20 kg	30 kg
	Dimensions HxWxD	907 x 408 x 408 mm	1053 x 484 x 484 mm
	Colours	All RAL and DB colours are available	All RAL and DB colours are available
	Options		

TARA

TARA T

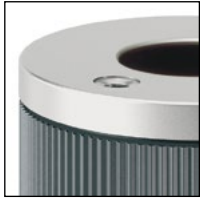
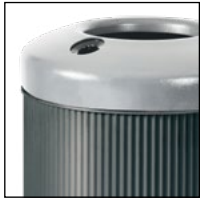

Details: Rounded top / Ashtray



Details: Rounded top / Inner liner

	Volume	100 l	100 l
	Emptying	Inner liner or waste bag	Door / Inner liner
	Material	Special steel top, Galvanised-painted steel	Special steel top, galvanised-painted steel
	Weight	59 kg	75 kg
	Dimensions HxWxD	870 x Ø 485 mm	870 x Ø 485 mm
	Colours	All RAL and DB colours are available	All RAL and DB colours are available
	Options	Rounded top	Rounded top
	Product family	Post-mounted bin page 9	

MULTILINE

ESSEN



Detail: Ashtray



Detail: Ashtray

	Volume	100 l	70 l
	Emptying	Inner liner or waste bag	Inner liner
	Material	Galvanised-painted steel	Galvanised-painted steel
	Weight	40 kg	29 kg
	Dimensions HxWxD	833 x Ø 500 mm	800 x Ø 475 mm
	Colours	All RAL and DB colours are available	All RAL and DB colours are available
	Options		

MARA 60

MARA 100



Detail: Ashtray

Detail: Ashtray

	Volume	60 l	100 l
	Emptying	Waste bag	Waste bag
	Material	Galvanised-painted steel	Galvanised-painted steel
	Weight	22 kg	35 kg
	Dimensions HxWxD	775 x 312 x 312 mm	870 x 410 x 410 mm
	Colours	All RAL and DB colours are available	All RAL and DB colours are available
	Options	Inner liner	Inner liner
	Product family	Post-mounted bin page 8	

SANTO SLIM

SANTO FLAT LID



Detail: Ashtray

Detail: bag holder

	Volume	100 l	90 l
	Emptying	Door / Waste bag	Waste bag
	Material	Galvanised-painted steel	Galvanised-painted steel
	Weight	40 kg	35 kg
	Dimensions HxWxD	1300 x Ø 400 mm	925 x Ø 400 mm
	Colours	All RAL and DB colours are available	All RAL and DB colours are available
	Options	Inner liner / Fill level measurement	Inner liner
	Product family	Post-mounted bin page 10, underground bin page 24	

SANTO 60

SANTO 70 T



Detail: Ashtray



Detail: Inner liner

	Volume	60 l	70 l
	Emptying	Waste bag	Door / Inner liner
	Material	Galvanised-painted steel	Galvanised-painted steel
	Weight	23 kg	45 kg
	Dimensions HxWxD	832 x Ø 350 mm	1025 x Ø 400 mm
	Colours	All RAL and DB colours are available	All RAL and DB colours are available
	Options		
	Product family	Post-mounted bin page 10, underground bin page 24	

SANTO 100

SANTO 100 T



Detail: Ashtray



Detail: Inner liner

	Volume	100 l	90 l
	Emptying	Waste bag	Door / Inner liner
	Material	Galvanised-painted steel	Galvanised-painted steel
	Weight	40 kg	53 kg
	Dimensions HxWxD	1025 x Ø 400 mm	1125 x Ø 400 mm
	Colours	All RAL and DB colours are available	All RAL and DB colours are available
	Options	Inner liner	
	Product family	Post-mounted bin page 10, underground bin page 24	

PINTO 50

PINTO 50 T



Detail: Ashtray



Detail: Inner liner

	Volume	50 l	50 l
	Emptying	Inner liner	Door / inner liner
	Material	Special steel top, galvanised-painted steel	Special steel top, galvanised-painted steel
	Weight	47 kg	59 kg
	Dimensions HxWxD	740 x Ø 440 mm	740 x Ø 440 mm
	Colours	All RAL and DB colours are available	All RAL and DB colours are available
	Options		
	Product family	Post-mounted bin page 9, Underground bin page 24	

PINTO 100

PINTO 100 T



Detail: Ashtray



Detail: Inner liner

	Volume	100 l	100 l
	Emptying	Inner liner oder waste bag	Door / inner liner
	Material	Special steel top, galvanised-painted steel	Special steel top, galvanised-painted steel
	Weight	59 kg	70 kg
	Dimensions HxWxD	870 x Ø 495 mm	870 x Ø 495 mm
	Colours	All RAL and DB colours are available	All RAL and DB colours are available
	Options		
	Product family	Post-mounted bin page 9, Underground bin page 24	

SORITO



Detail: Ashtray / open lid



PORTELLO



Detail: Ashtray

	Volume	100 l	50 l
	Emptying	Waste bag	Discharge container
	Material	Galvanised-painted steel	Alu + Galvanised-painted steel
	Weight	25 kg	24 kg
	Dimensions HxWxD	1031 x Ø 470 mm	917 x 505 x 361 mm
	Colours	All RAL and DB colours are available	All RAL and DB colours are available
	Options		

SOLOBIN



Detail: Ashtray



	Volume	75 l	
	Emptying	Inner liner	
	Material	Stainless steel	
	Weight	42 kg	
	Dimensions HxWxD	917 x Ø 440 mm	
	Colours		
	Options		



RECYCLING BINS



CANTO



Detail: deposit openings

Detail: Inner liner, cup collector

	Volume	2 x 30 L	3 x 30 L	4 x 30 L	5 x 30 L
	Emptying	One plastic innerliner per waste fraction			
	Material	Stainless steel / HDPE			
	Weight	48 kg	61 kg	74 kg	87 kg
	Dimensions HxWxD	730 x 650 x 387 mm	730 x 895 x 387 mm	730 x 1140 x 387 mm	730 x 1385 x 387 mm
	Colours	Stainless steel brushed / powder coated			
	Options	Cup Collector, Individual deposit openings, individual sticker on request			

RECYCLING BINS

CAMPUS GOOOL



Detail: Inner liner, waste bag

Details: Lid hinge, lid side

	Volume	135 / 3 x 45 l
	Emptying	3 Inner liner
	Material	HDPE, virgin or recycling material
	Weight	20 kg
	Dimensions HxWxD	577 x 1100 x 385 mm
	Colours	Standard colours grey and black; Special colours and material effects available
	Options	Individual insertion openings possible, sticker on request

CAMPUS



reddot design award

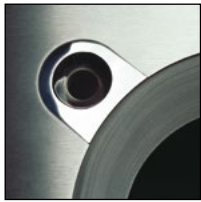

Detail: Ashtray



	SOLO	DUO	TRIO	QUATTRO
Volume	60 l	120 / 2 x 60 l	180 / 3 x 60 l	240 / 4 x 60 l
Emptying	Waste bag / Inner liner	Waste bag / Inner liner	Waste bag / Inner liner	Waste bag / Inner liner
Material	Stainless steel	Stainless steel	Stainless steel	Stainless steel
Weight	27 kg	45 kg	65 kg	85 kg
Dimensions HxWxD	850 x Ø 420 mm	850 x 750 x 370 mm	850 x 1083 x 370 mm	850 x 1440 x 370 mm
Colours				
Options				

CAMPUS ECO



Details: Open lid,
View from top

	DUO	TRIO	QUATTRO
Volume	2 x 60 l	3 x 60 l	4 x 60 l
Emptying	Waste bag / Inner liner	Waste bag / Inner liner	Waste bag / Inner liner
Material	Galvanised-painted steel	Galvanised-painted steel	Galvanised-painted steel
Weight	45 kg	60 kg	80 kg
Dimensions HxWxD	766 x 750 x 370 mm	766 x 1040 x 370 mm	766 x 1380 x 370 mm
Colours	all RAL colours	all RAL colours	all RAL colours
Options	Stainless steel	Stainless steel	Stainless steel







DRIVE IN STATION



RECYCLING BINS



Detail: Filling from both sides

	Volume	3 x 120 L
	Emptying	2-wheel containers
	Material	Galvanised-painted steel
	Weight	315 kg
	Dimensions HxWxD	2414 x 950 x 1346 mm
	Colours	All RAL and DB colours are available
	Options	Individual insertion openings possible, Fill level measurement

UNDERGROUND LITTER BINS



MINI XXL











Underground bin with all-round drainage



Detail: Lock



	SANTO	PINTO	TANO
 Volume	650 -1000 l	650 -1000 l	650 -1000 l
 Emptying	Removal by suction	Removal by suction	Removal by suction
 Material insertion pillar	Galvanised-painted / stainless steel	Galvanised-painted steel	Stainless steel
 Pillar HxBxT	902 x 304 x 304 mm	742 x 330 x 330 mm	975 x 327 x 327 mm
 Colours	All RAL and DB colours	All RAL and DB colours	
 Options	Inclination adjustment	Inclination adjustment	
 Material Underground bin	Galvanised steel	Galvanised steel	Galvanised steel
 Underground bin HxBxT	927-1242 x 1110 x 910 mm	927-1242 x 1110 x 910 mm	927-1242 x 1110 x 910 mm
 Product family	Post-mounted bin page 10 Free standing bin page 15	Post-mounted bin page 9 Free standing bin page 16	

Mini XXL is a system of large underground containers which can be combined with various insertion columns above ground.

For waste disposal with removal by suction, a separate flap allows optimum access to the underground container and prevents the creation of a vacuum. This enables a pleasant street scene environment in places where large amounts of litter occur. The space saved chiefly benefits pedestrians and cyclists. Incline adjustment of the column allows the installation in an area with an incline of up to 5°.

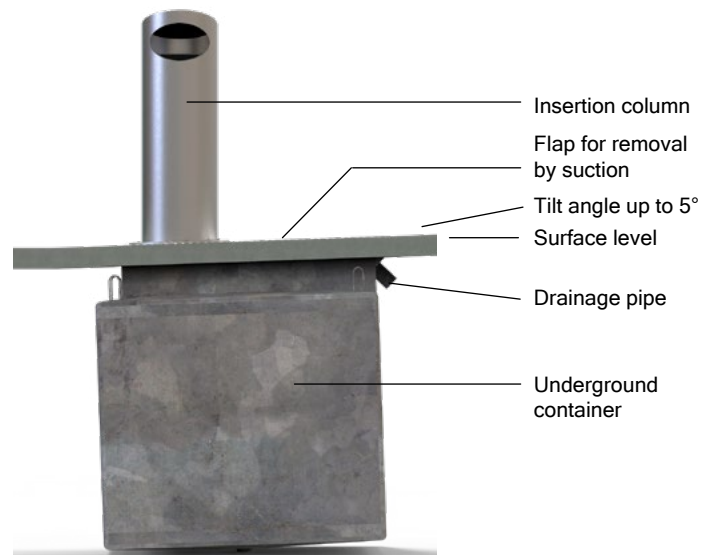

CONTAINER SHELTERS



DRIVE IN



	120	240	360
Volume	ca. 120 l	ca. 240 l	ca. 360 l
Material	Galvanised-painted / stainless steel	Galvanised-painted / stainless steel	Galvanised-painted / stainless steel
Weight	125 kg	155 kg	175 kg
Dimensions HxWxD	1270 x 587 x 587 mm	1465 x 766 x 766 mm	1530 x 750 x 940 mm
Colours	All RAL and DB colours	All RAL and DB colours	All RAL and DB colours
Options	Ashtray	Ashtray	Ashtray

"Drive In" is not a litter bin, it is a bin housing for a wheeled bin. Standard two-wheel 120, 240 and 360 litre plastic bins thus fit discreetly into their surroundings.

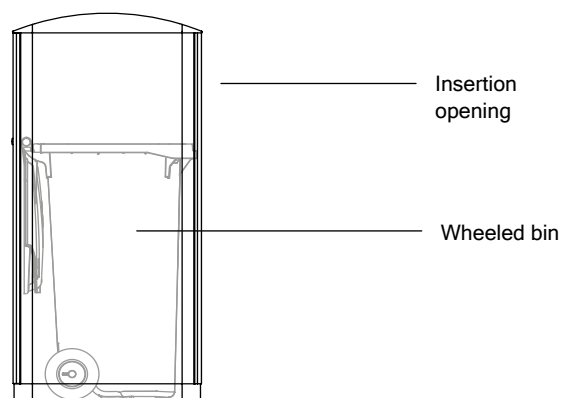

UNIQUE ORIGINALS!



ESE - WE VALUE YOUR RECYCLABLES



KERBSIDE SYSTEMS
MOBILE CONTAINERS FOR
WASTE AND RECYCLABLES



BRING SYSTEMS
(SEMI-) UNDERGROUND SYSTEMS
COLLECTION BANKS



BIO SELECT LINE
CONTAINERS AND COMPOSTERS
FOR GARDEN AND BIO WASTE



HAZARDOUS WASTE CONTAINERS
MOBILE FUEL CONTAINERS
MOBILE OIL CHANGE UNITS



PUBLIC FURNISHING
BINS FOR THE PUBLIC SPACE



CONTAINER MANAGEMENT
DISTRIBUTION, REGISTRATION,
COLLECTION AND RECYCLING

ESE is Europe's leading manufacturer of temporary storage solutions for waste and recyclables. Our comprehensive range of products is complemented by a full service offer from container management to the recycling of products at the end of their lifetime. Specialists in all departments develop solutions to meet our customers' requirements. In doing so, we follow the principle of highest possible sustainability from product development and production to transport.